

Scanner Basic Configuration: Part-No. HW-Z420-01-000-01

3D Terrestrial Scanner Hardware LMS-Z420i Part-No. HW-Z420-00-000-01

High performance 3D Laser Scanner, specifications and laser classification according to the latest **datasheet LMS-Z420i**



Vertical tripod mount Part-No. HW-ZXX-06-005-00

Interfaces, integrated

- TCP/IP Interface, providing smooth integration of the LMS-Z420i data into a 10/100 MBit/sec, twisted-pair (TP) Local Area Network (LAN). The interface acts as a server allowing remote configuration and data acquisition via a platform-independent TCP/IP (Ethernet) Interface.
- ECP parallel data Interface
- RS232, 19.2 kBd for scanner configuration via PC or laptop

Cables

- Part-No. HW-GP-03-008-00 TCP/IP Cable M12-M12, 0.5 m, angled (Ethernet)
- Part-No. HW-GP-03-000-00 TCP/IP Cable M12-M12, 3 m
- Part-No. HW-GP-03-002-00 TCP/IP Cable M12-RJ45, 0.3 m
- Part-No. HW-GP-03-003-00 TCP/IP Cable M12-RJ45 cross over, 0.3 m
- Part-No. HW-GP-03-010-00 Serial Data Cable, RS232, 0.9 m
- Part-No. HW-ZXX-03-002-00 Power Supply Cable, 7 pole connector, 3 m

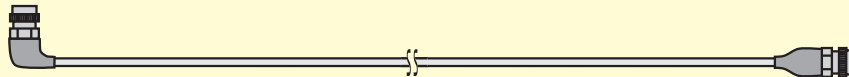

- Part-No. HW-GP-03-004-00 Adapter Cable, 1 m, from power supply cable to banana plugs

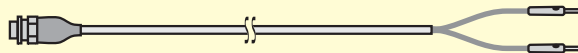

- Part-No. HW-GP-03-005-00 Adapter Cable, 1 m, from power supply cable to cigarette lighter plug

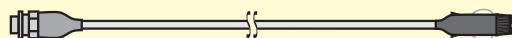

Retroreflectors

- 100 pcs. of flat circular retroreflectors, white, diameter 50 mm Part-No. HW-GP-06-002-00
- 5 pcs. of flat circular retroreflectors, white, diameter 100 mm Part-No. HW-GP-06-004-00

Scanner Basic Configuration continued next page



RiSCAN PRO Viewer, Acquisition & Processing Software Part-No. SW-GP-07-000-00

For detailed description of main functions see RiSCAN PRO datasheet.

- The companion software package to the *RIEGL* Terrestrial Laser Scanner products
- Using a well-documented tree structure for comfortable access and clarity
- Project oriented, XML file format
- For operating systems WINDOWS XP (recommended), WINDOWS 2000 SP2 or above

includes:

- RiSCAN PRO Viewer License
for visualizing of already acquired RiSCAN PRO projects and simple data evaluation
- RiSCAN PRO Acquisition License
for *RIEGL* scanner configuration and data acquisition, global scan data registration, viewing and export of merged, filtered pointclouds
- RiSCAN PRO Processing Single User License (Dongle)
for advanced data processing and evaluation of already acquired RiSCAN PRO projects

RiScanLib OFFLINE Scan Library Part-No. SW-GP-07-002-00

- The basic version of the RiScanLib allows the software developer the offline scan data decoding from a 3dd file. This library will assist the software developer in writing an own software application. Since the RiScanLib is based on COM technology it can be used in many programming languages. It consists of several DLL's for scan data decoding.
- "Visual C++" example and full documentation is included
- For operating systems WINDOWS XP (recommended), WINDOWS 2000 SP2 or above

RiPORT Driver Part-No. SW-GP-07-001-00

(included within RiSCAN PRO Acquisition License)

- Low-level data acquisition via ECP on PC platform
- Code examples for C++
- For operating systems WINDOWS XP (recommended), WINDOWS 2000 SP2 or above

Firmware maintenance for 12 months Part-No. FW-Z420-12-000-01

- Free firmware updates

RiSCAN PRO Software maintenance for 12 months Part-No. ST-GP-06-000-00

- Free software updates
- E-mail and telephone support

User's Manual (in English language)

"Technical Documentation & User's Instructions"
including, between other things, instructions for: Safety, Installation, Operation, etc.

Scanner Basic Configuration Package Part-No. HW-Z420-01-000-01



Scanner Software Options:

Free software updates and e-mail/telephone support for 12 months included.

RiSCAN PRO Processing Network Server License

Part-No. SW-GP-02-003-00

Includes 10 licenses for RiSCAN PRO Processing, administrated by a network server program. Licenses can be allocated to single processing computers in the same network. Checking out of single licenses to a USB dongle is possible.
2 dongles added to scope of delivery.
Single User License mandatory.

License RiSCAN PRO Plugin Camera Module Part-No. SW-GP-02-000-00

Enables automatic acquisition of calibrated and orientated images via USB or IEEE 1394 "firewire".

License RiSCAN PRO Plugin Multi Station Adjustment Module

Part-No. SW-GP-02-001-00

- Advanced registration based on overlapping pointclouds
- Advanced registration and adjustment based on tiepoints, controlpoints
- Advanced registration and adjustment based on additional plane information

License RiScanLib ONLINE Scan Library Part-No. SW-GP-02-002-00

The online version of the RiScanLib library assists the software developer in writing an own software application for an LMS-Zxxx scanner, i.e. to control the scanner and to acquire scan data online via TCP/IP or parallel port.

Since the RiScanLib is based on COM technology it can be used in many programming languages. It consists of separate DLL's for scanner configuration, reflector extraction, and scan data decoding.

"Visual C++" example and full documentation is included.

For operating systems WINDOWS XP (recommended), WINDOWS 2000 SP2 or above.



Scanner Hardware Options:

Inclination Sensors for vertical scanner setup position

Part-No. HW-ZXX-06-006-00

The optionally built-in inclination sensors serve to acquire the 3D position of the scanner in relation to the vertical Z-axis (within the X- and Y-axes).

- smoothly integrated into the *RIEGL* TLS hardware
- utilization of inclination data by RiSCAN PRO's backsighting functions
- angular correction applicable for vertical scanner setup position
- angular tilt range ± 10 deg
- accuracy typ. ± 0.008 deg ¹⁾



¹⁾ One sigma value under *RIEGL* test conditions.

Internal Sync Timer for GPS-synchronized time stamping of scan data

Internal Sync Timer Part-No. HW-GP-02-000-00

The scanner optionally offers a time-stamping mechanism to add real-time-clock information to each laser range measurement. Taking full advantage of this feature needs, e.g.

- a GPS synchronization output line, sending SYNC pulses in periods of 1 second (1 PPS), permanently connected to a scanner input line (Trigger input).
- the GPS serial RS232 port connected to a PC controlling the scanner for time synchronization purposes (by means of the *RIEGL* software tool RiSYNC) prior to scan data acquisition or for synchronization checks.

Both SYNC pulse as well as RS232 interface are standard for GPS receivers.

RiSYNC Single User License Part-No. SW-GP-02-005-00

Software tool to synchronize the scanner's time with the time gained by the Global Positioning System (GPS)

RiSYNC License Scope of Delivery:

- CD coming with software setup and online help-manual
- License Certificate including License Code related to serial number of *RIEGL* scanner in use
- User's manual in printed form
- E-Mail and telephone support for 12 months from delivery
- Software updates within 12 months from delivery

Special Power Supply Cable Part-No. HW-ZXX-03-014-00

Special power supply cable for external connection and reset of the internal sync timer, length approx. 4 m.

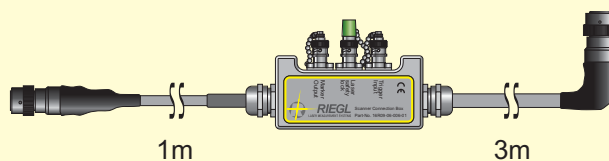



Services:

Two-day training [Part-No. ST-GP-11-000-00](#)

Regarding the hardware as well as the operating software RiSCAN PRO. The training will be held either at our site in Horn, Austria, or at your site (travelling and accommodation expenses to be added).

Intensified additional training [Part-No. ST-GP-11-001-00](#)

Covers advanced working with the scanner hardware as well as processing of the acquired data with RiSCAN PRO.

Price per 8 hours working day (travelling expenses to be added).

Digital Camera Calibration Service for up to three camera lenses

[Part-No. ST-GP-11-002-00](#)

Provides complete set of camera calibration parameters for use in RiSCAN PRO including internal calibration, lens distortion parameters and mounting calibration parameters. Parameters are delivered within a RiSCAN PRO project. Calibration statistics included (available for camera-lens combinations as recommended by RIEGL LMS).



Power Supply Modules:

Rechargeable NiMH Battery

13.2 V, 18 Ah, with fuse, weight 3.55 kg

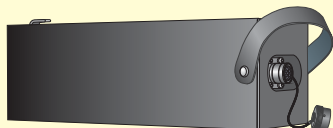

Part-No. HW-GP-04-000-00

Automatic Charger

100 - 240 V AC, short circuit proof, weight 0.4 kg



Part-No. HW-GP-04-001-00

Adapter Cable, 1 m, from 7 pole power supply cable to 12 V PbGel battery with "quick action" battery pole connectors

Part-No. HW-GP-03-006-00

12 V PbGel Battery

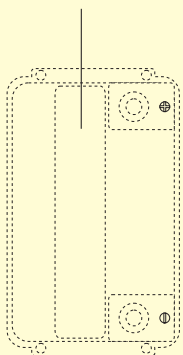

Adapter Cable as above, but with "crocodile" battery pole connectors

Part-No. HW-GP-03-007-00

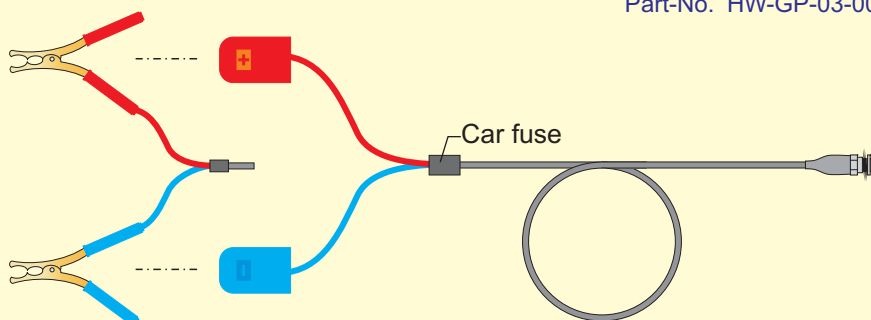

AC Power Supply Unit

Input 100 - 240 V AC, 50 - 60 Hz, output 15 V DC, 7.5 A, weight 1.4 kg



Part-No. HW-ZXX-04-000-00



Reflectors:

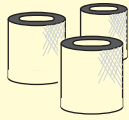

Cylindrical Retroreflectors, ²⁾
height 50 mm x diameter 50 mm each, hole diameter 24.3 mm
Part-No. HW-GP-06-005-00

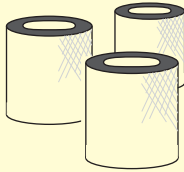

Cylindrical Retroreflectors, ²⁾
height 100 mm x diameter 100 mm each, hole diameter 24.3 mm
Part-No. HW-GP-06-007-00

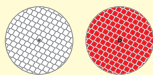

Flat Circular Retroreflectors, ³⁾
centre hole diameter 3 mm, self-adhesive

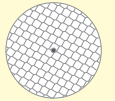

diameter 50 mm, white
Part-No. HW-GP-06-002-00

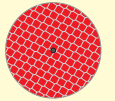

diameter 50 mm, red
Part-No. HW-GP-06-009-00

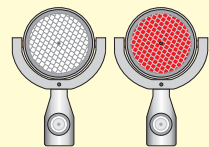

front side back side

diameter 100 mm, white
Part-No. HW-GP-06-003-00

diameter 100 mm, red
Part-No. HW-GP-06-010-00

Biaxial Bireflex Flat Circular Retroreflectors, ³⁾
plastic reflector support, mounted on universal joints,
with foil coating on both sides
(diameter 50 mm, centre hole diameter 3 mm)

Part-No. HW-GP-06-011-00

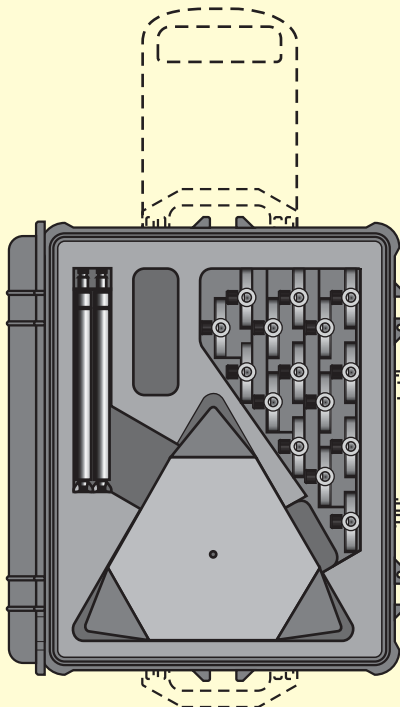

Complete Set of
Biaxial Bireflex Flat Circular
Retroreflectors, ³⁾
comprising 15 retroreflectors
mounted on convergence bolts
(standard length 250 mm,
R 3/8" threads),
15 triangle support feet,
and a stable carrying case
(dimensions: 624 x 490 x 303 mm)
with 4 hinged handgrips and wheels.
Part-No. HW-GP-06-012-00

Notes:

1. High transportation costs because of the high weight.
2. Can be delivered within EUROPE only.

²⁾ Intended for prior surveying by DGPS. Cylindrical retroreflectors to be mounted in vertical orientation only.
³⁾ Intended to be used with totalstation (theodolite) as control points in RiSCAN PRO and RiPROFILE projects!



Carrying Cases:

Heavy-duty **Scanner Carrying Case CC-Z620** with 4 hinged handgrips and wheels, splash-water proof, foam-lined to fit shape of LMS-Z620, mount for manual tilt and cables.
Dimensions: 785 x 520 x 295 mm

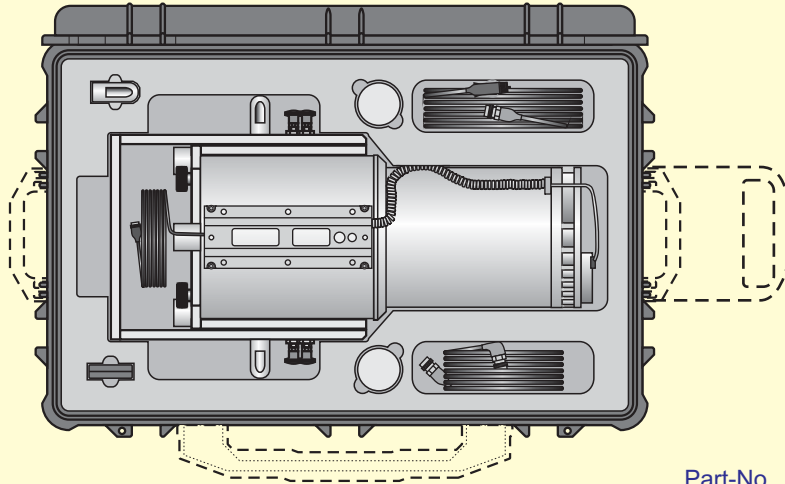

Part-No. HW-ZXX-05-000-00

3 pcs. additional foam-inserts for the scanner carrying case, to be used if the scanner is not equipped with the manual tilt mount.

Part-No. HW-ZXX-05-001-00
in the Scanner Carrying Case's price included

Heavy-duty **Camera Carrying Case**, splash-water proof, foam-lined to fit shape of camera, lenses, camera mount, and camera accessories.
Dimensions: 525 x 440 x 220 mm

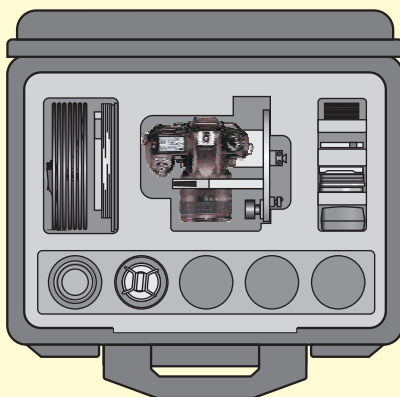

for Nikon D200 / D90 / D300(s) / D700:
Part-No. HW-ZXX-05-002-00



Further Accessories:

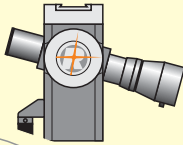

Telescope 3 x 20, on tilt mount, detachable (fitting for the base plate)

Part-No. HW-ZXX-06-007-00

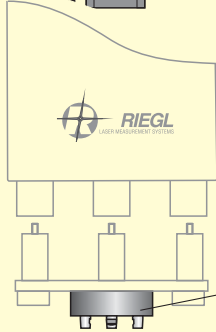

Adapter for tribrach

Part-No. HW-GP-06-013-00



Adjustable tribrach for mounting the LMS-Z620 on a professional tripod

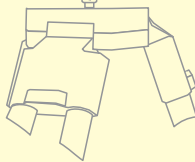

Note:

Scanner mounted on a tribrach to be used only in vertical position!

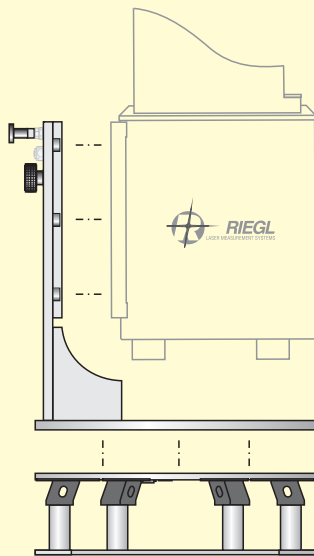

Tilt mount for vehicles

Part-No. HW-ZXX-06-008-00

Shock-absorbing mount SPM-Zxxx, made of stainless steel mounting plates and optimized shock-absorbing rubber elements

Part-No. HW-ZXX-06-009-00

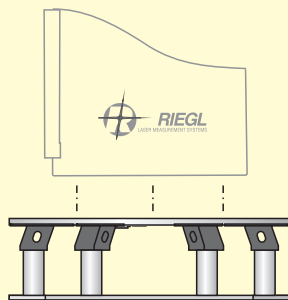

Shock-absorbing mount SPM-Zxxx, made of stainless steel mounting plates and optimized shock-absorbing rubber elements

Part-No. HW-ZXX-06-009-00