

DIGITAL LASER DISTANCE METER **LD05-A10GF**

with glass-fiber coupled remote optical head



The *RIEGL* LD05-A10GF is a **multi-purpose laser distance meter** based on precise time-of-flight laser range measurement especially suited for demanding applications under critical environmental conditions (i.e. high ambient temperature, hazardous environment).

It uses state-of-the-art **digital signal processing** to enable precise distance measurement for complex multi-target situations even under bad visibility conditions. Digitizing the echo signal and subsequent analysis enables multi-target distance measurements.

The measuring system consists of an optical head meeting the requirements of the relevant application **and a separate electronics box, connected by a duplex glass-fiber cable** of variable length with connectors on both sides.

- **Electronics unit and measuring head** can be **mounted separately** according to requirements resulting from critical environmental conditions
- **Further improved measurement capability** in demanding situations **causing poor visibility** (rain, dust, fog).
- Short infrared laser pulses providing **excellent interference immunity**
- Narrow measurement beam with low divergence for **excellent spatial resolution**
- **Measurement to almost any surface** regardless of the angle of incidence of the beam and the surface characteristics
- Significant enhancement of the maximum range based on **pre-detection-averaging**

visit our webpage
www.riegl.com

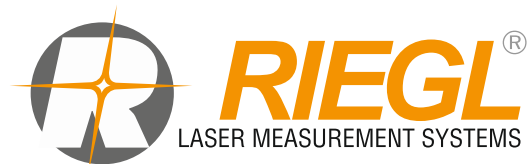

The LD05-A10GF can be configured for various application modes:

- **High Penetration Mode** for complex target situations using a sequence of laser shots, providing a self-adapting (rather low) data update rate
Significant enhancement of the maximum range based on Pre-Detection-Averaging
- **Fast Mode** is a balanced mixture of the High Speed and High Penetration Modes, which provides very high data update rate
- **High Speed Mode** for simple target situations and an extremely high data update rate

Principle of Operation

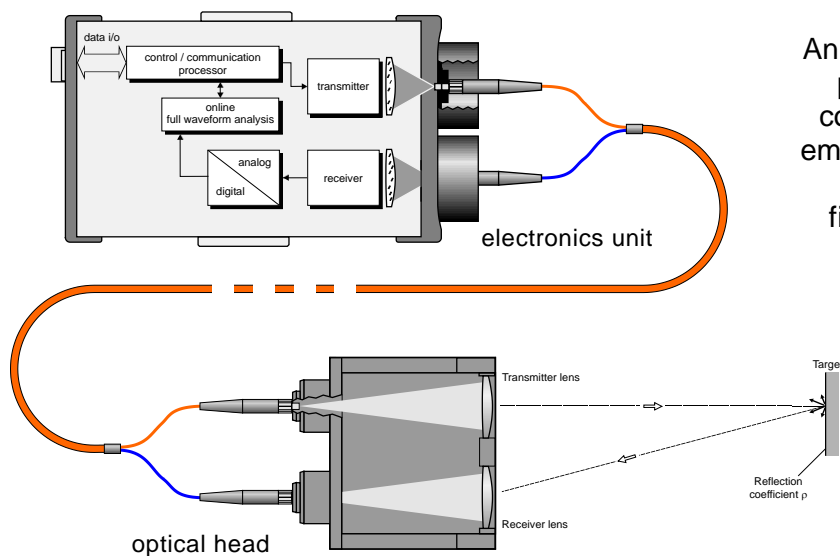

An electrical pulse generator periodically drives a semiconductor laser transmitter, emitting infrared light pulses, which are fed into a glass fiber cable. The pulses are guided to the optical head and collimated by the transmitter lens. Part of the echo signal reflected by the target is coupled into the glass fiber cable via the receiver lens and guided back to the electronics unit.

A receiver converts the optical echo signal into an electrical signal, which is digitized internally and subsequently forwarded to a subsystem for on-line full waveform analysis. Sophisticated algorithms for waveform analysis improve the instrument's capabilities to measure the desired target even in the presence of smoke, fumes or dust.

Features and Advantages:

- The LD05-A10GF electronics unit can be combined with **various optical heads** to suit nearly any requirement.
- The **optical head contains no electronics** and is therefore extremely small, light-weight, inexpensive, high-temperature resistant, and insensitive to electromagnetic or ionizing radiation.
- The **duplex glass-fiber cable** connecting the electronics unit and the optical head provides galvanic insulation between optical head and electronics box. Its length can be specified with options ranging from **4m to more than 100m**.

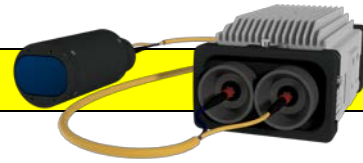

Performance Examples

LD05-A10GF (equipped with MK36)

High Penetration Mode	
Measurement range ¹⁾ for natural targets, $\rho \geq 80\%$ for natural targets, $\rho \geq 10\%$ reflector foil ²⁾ & plastic cat's-eye reflector	up to 250 m up to 90 m up to 1100 m
Minimum range	1 m
Measurement accuracy ^{3) 4) 5)}	typ. ± 8 mm
Measurement precision ^{3) 6)}	typ. ± 5 mm
Measurement rate ⁷⁾	typ. 100 Hz
Max. number of targets	5
Fast Mode	
Measurement range ¹⁾ for natural targets, $\rho \geq 80\%$ for natural targets, $\rho \geq 10\%$ reflector foil ²⁾ & plastic cat's-eye reflector	up to 130 m up to 45 m up to 600 m
Minimum range	1 m
Measurement accuracy ^{3) 4) 5)}	typ. ± 10 mm
Measurement precision ^{3) 6)}	typ. ± 7 mm
Measurement rate	2500 Hz
Max. number of targets	5
High Speed Mode	
Measurement range ¹⁾ for natural targets, $\rho \geq 80\%$ for natural targets, $\rho \geq 10\%$ reflector foil ²⁾ & plastic cat's-eye reflector	up to 100 m up to 35 m up to 500 m
Minimum range	1 m
Measurement accuracy ^{3) 4) 5)}	typ. ± 14 mm
Measurement precision ^{3) 6)}	typ. ± 10 mm
Measurement rate	10000 Hz
Max. number of targets	5

- 1) The following conditions are assumed
 - target is larger than footprint of laser beam, • perpendicular angle of incidence, • visibility 10 km
 - typical values for average ambient brightness conditions. In bright sunlight, the operational range is considerably shorter than under an overcast sky. At dawn or at night the range is even higher.
- 2) Reflecting foil 3M DG4090 or equivalent, dimensions $\geq 0.45 \times 0.45 \text{ m}^2$.
- 3) One sigma standard deviation @ 50 m range under *RIEGL* test conditions.
- 4) Plus distance dependent error $\leq \pm 20$ ppm.
- 5) Accuracy is the degree of conformity of a measured quantity to its actual (true) value.
- 6) Precision, also called reproducibility or repeatability, is the degree to which further measurements show the same result.
- 7) With self-adapting measurement time selected, the effective data update rate depends on the number of targets and their reflectivity and distance.

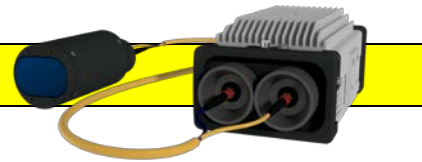

Increasing Measurement Range

The measurement range can be increased by summing echo signals of multiple laser shots (pre-detection averaging) ¹⁾. The position of the target must be stable while a measurement is executed.

The following diagram shows the maximum measurement range versus pre-detection averaging value without any atmospheric attenuation. Depending on atmospheric visibility, the resulting maximum range can be further reduced.

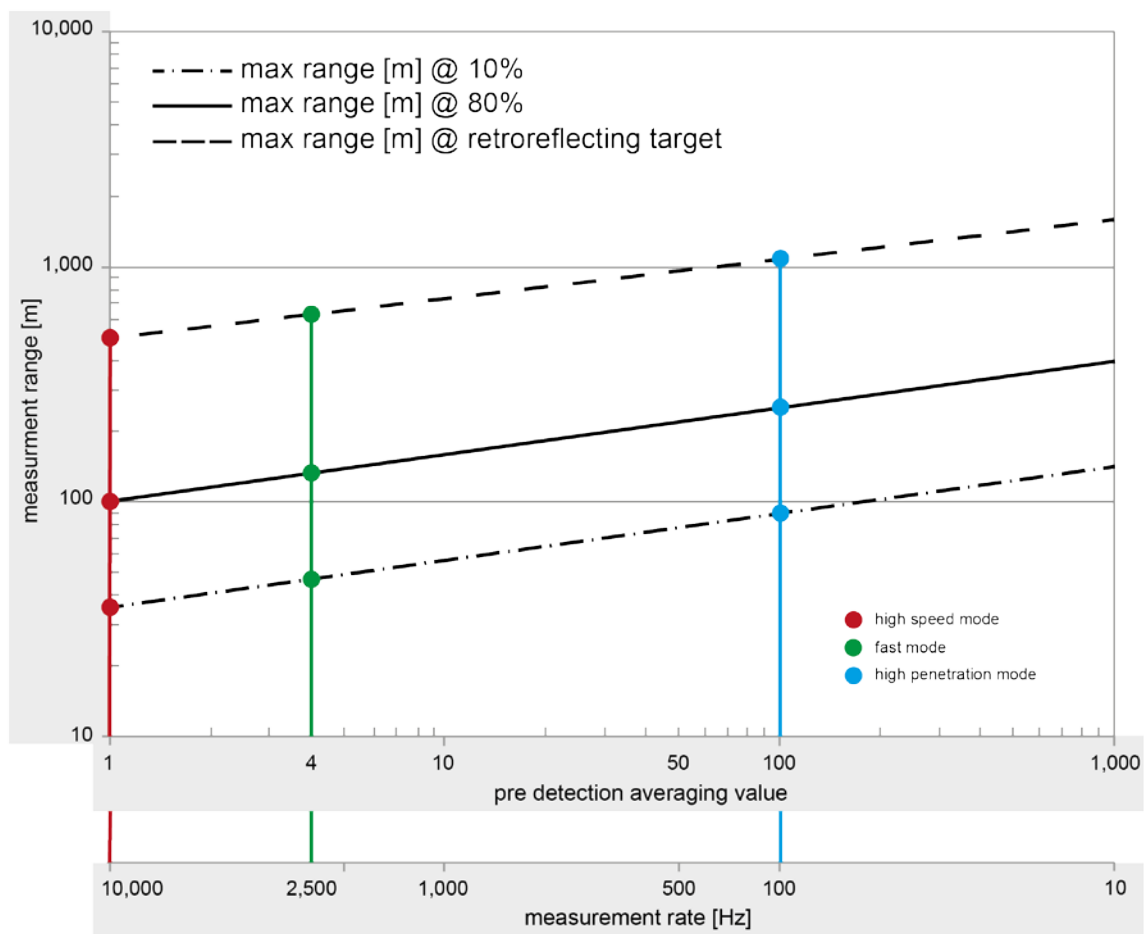

- 1) The following conditions are assumed
- target is larger than footprint of laser beam, • perpendicular angle of incidence, • visibility 10 km
 - typical values for average ambient brightness conditions. In bright sunlight, the operational range is considerably shorter than under an overcast sky. At dawn or at night the range is even higher.

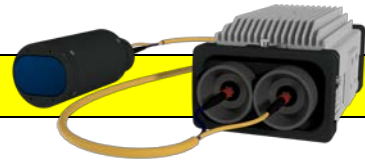

Laser Specifications

LD05-A10GF (MK36)

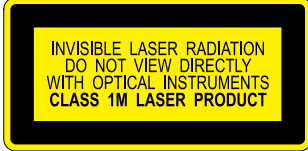
Wavelength	near infrared
Beam divergence ¹⁾	2.4 mrad
Laser product classification according to IEC 60825-1:2007 The following clause applies for instruments delivered into the United States: Complies with 21 CFR 1040.10 and 1040.11 except for deviations pursuant to Laser Notice No. 50, dated June 24, 2007.	Laser Class 1M  Viewing the laser output with certain optical instruments designed for use at a distance (for example, telescopes and binoculars) may pose an eye hazard.

1) Measured at the 1/e² points. 1mrad corresponds to 10 cm beam width per 100 m distance.

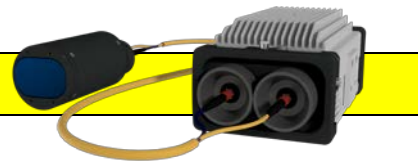

General Technical Data – Electronics Unit

LD05-A10GF

Data interfaces	
Data port	TCP/IP, 10/100/1000 MBit port or RS232/RS422
Configuration port	TCP/IP, 10/100/1000 MBit port or RS232/RS422
WEB interface	TCP/IP
Power supply	11 – 28 V DC, 24 VDC nominal
Power consumption	18 W
Main dimensions (L x W x H) mm	246x130x97
Weight	approx. 2.8 kg
Protection class	IP64
Temperature range	
Operation	-10°C up to +50°C ¹⁾
Storage	-20°C up to +60°C ¹⁾
Mounting	Flanges on both sides
Analog Output	4 – 20 mA ²⁾ , not galvanically isolated, resolution 16 Bit, linearity 1 ‰ of full scale
Switching Output	2 x PNP transistor driver ³⁾ , built-in thermal and short-circuit protection, switching current 200 mA max., switching voltage = supply voltage

- 1) The life expectancy (MTBF) of the instrument is reduced in case of operation and/or storage at high temperatures.
- 2) Operating range selectable via TCP/IP port or serial interface.
- 3) Switching points adjustable via TCP/IP port or serial interface.

Technical Data LD05-A10GF

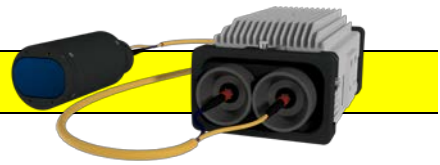

Dimensional Drawings LD05-A10GF

rear view

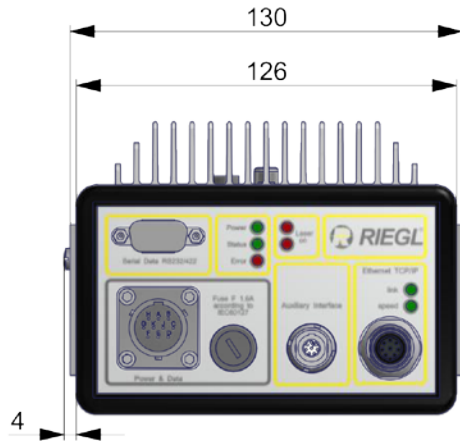

front view

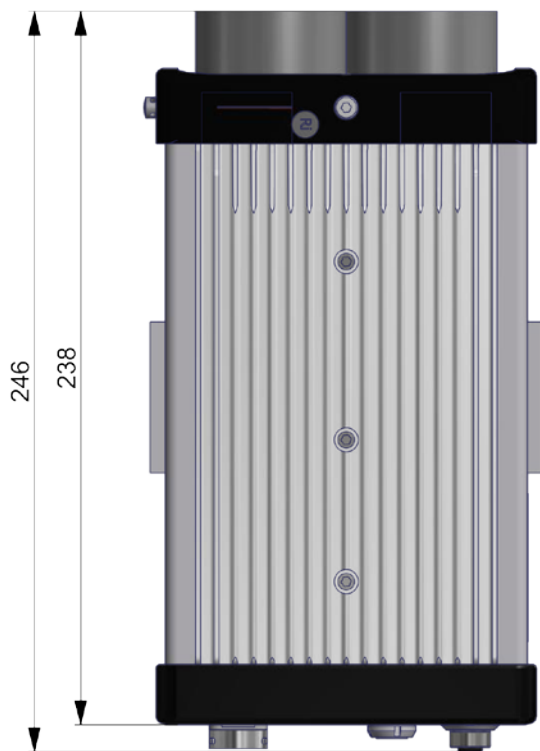
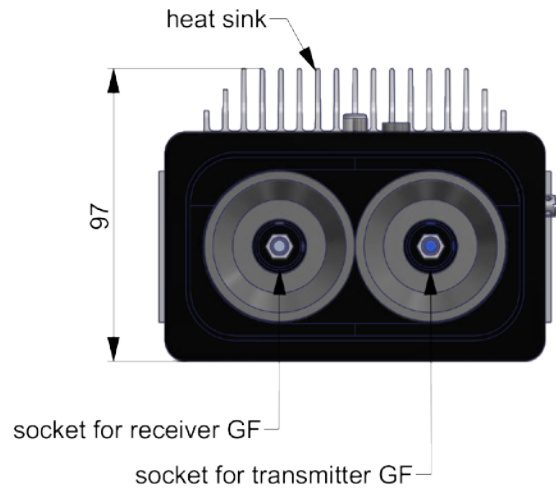

top view

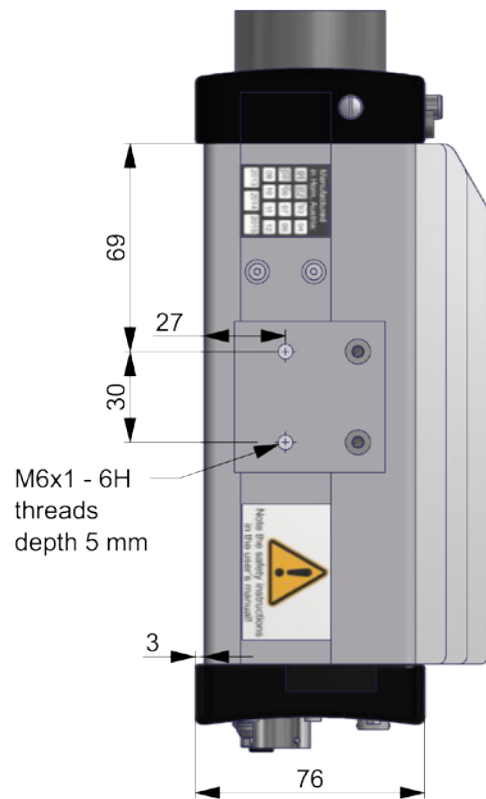

side view

All dimensions in mm

Technical Data Optical Heads

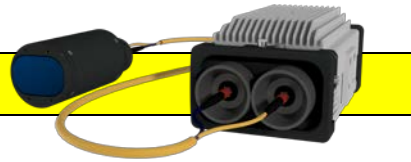

Remote Optical Head MK36:

case: aluminium, black anodized
main dimensions: 120 x 80 x 50 mm
weight: 0.67 kg
protection class: IP62 (glass fiber cables attached)
temperature range: -20° to +80° C (operation and storage)

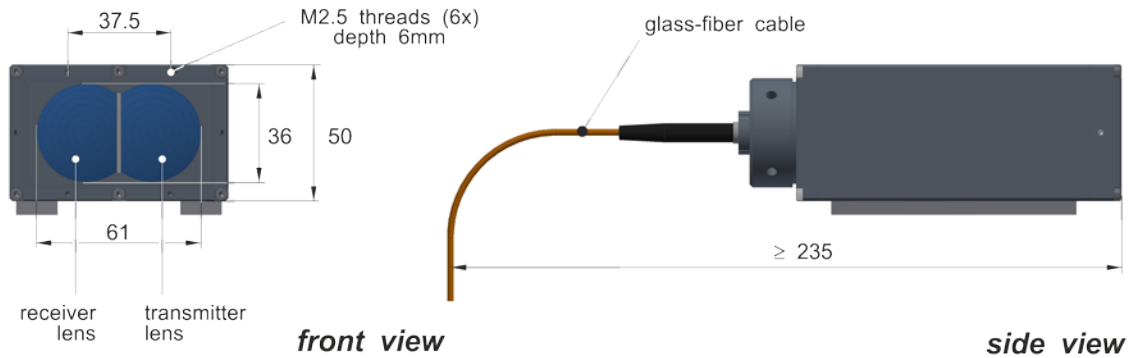

All dimensions in mm.

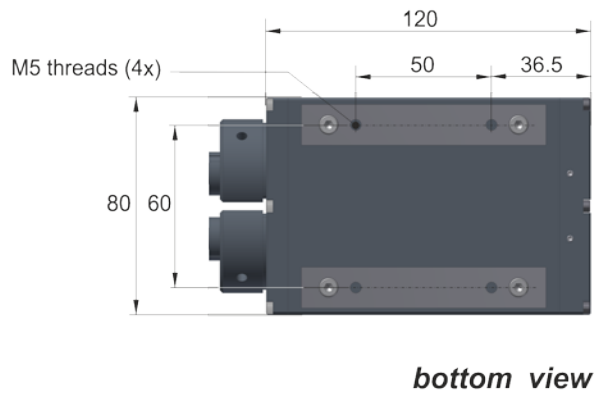

Technical Data Optical Heads

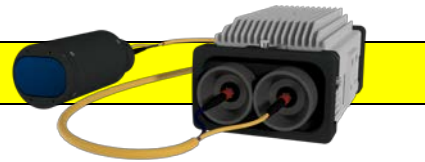

Remote Optical Head MK36-Z65:

case: aluminium, black anodized
(stainless steel version on request)
main dimensions: 137 x Ø 65 mm
weight: 0.4 kg
protection class: IP62 (glass fiber cables attached)
temperature range: -20° to +80° C (operation and storage)

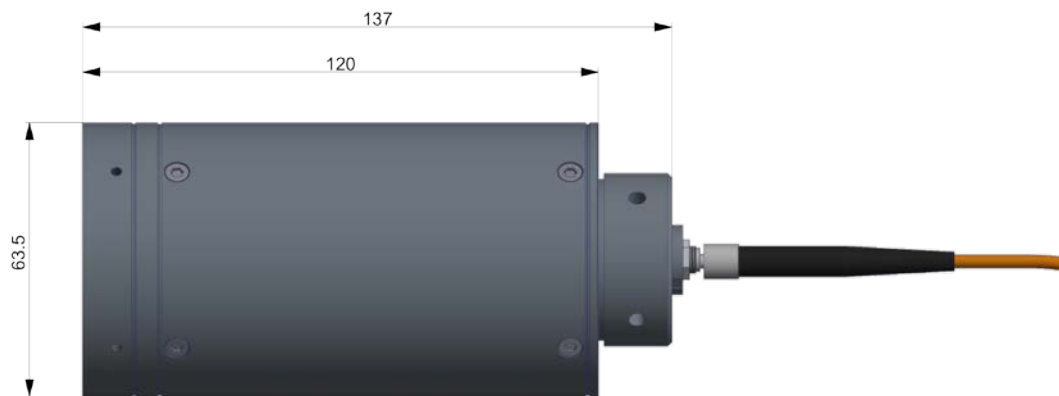

SIDE VIEW

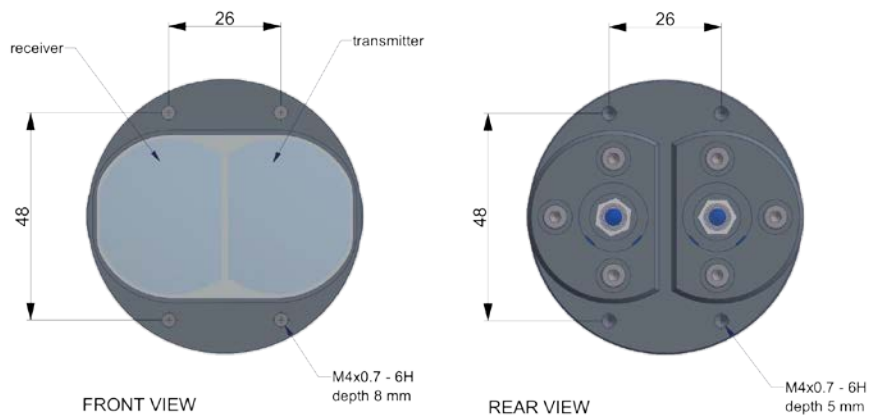

FRONT VIEW

REAR VIEW

all dimensions in mm

Technical Data Optical Heads

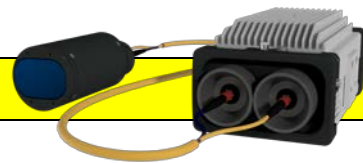

Remote Optical Head MK36-PT:

case:	aluminium, black anodized
main dimensions:	500 x 120 x 70 mm
weight:	approx. 4.4 kg
protection class:	IP62 (glass fiber cables attached)
temperature range:	-20° to +80° C (operation and storage)
recommended air pressure:	2 – 4 bar

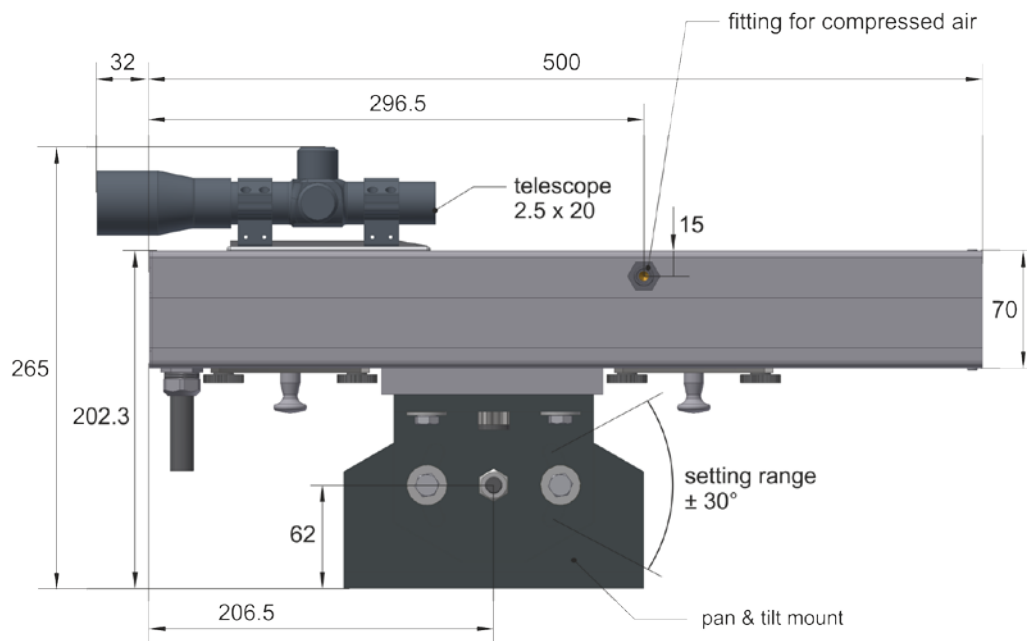

side view

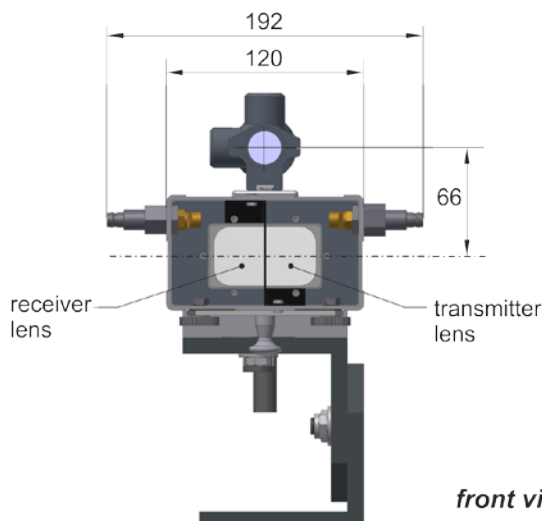

front view

All dimensions in mm.

Copyright RIEGL Laser Measurement Systems GmbH © 2017 – All rights reserved. Use of this data sheet other than for personal purposes requires RIEGL's written consent. This data sheet is compiled with care. However, errors cannot be fully excluded and alternations might be necessary. Data Sheet, RIEGL LD05-A10GF, 2017-11-21, page 10 of 10